

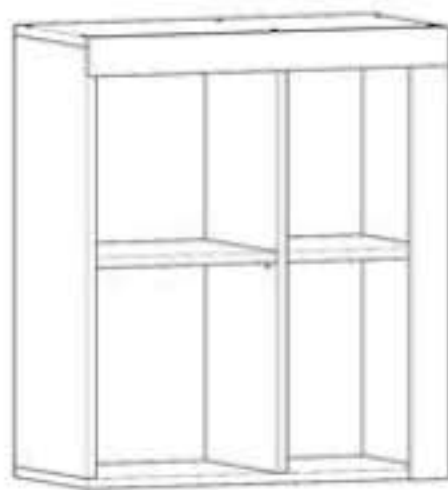

RO INSTRUCTIUNI DE MONTAJ
 EN INSTALLATION INSTRUCTIONS
 DE INSTALLATIONSANLEITUNG
 FR INSTRUCTIONS D'INSTALLATION
 IT ISTRUZIONI PER L'INSTALLAZIONE
 HU SZERELÉSI ÚTMUTATÓ
 UK ІНСТРУКЦІЇ ДО МОНТАЖУ
 SR УПУТСТВО ЗА ИНСТАЛАЦИЈУ
 BG ИНСТРУКЦИИ ЗА ИНСТАЛАЦИЯ
 RU ИНСТРУКЦИИ ДО МОНТАЖУ

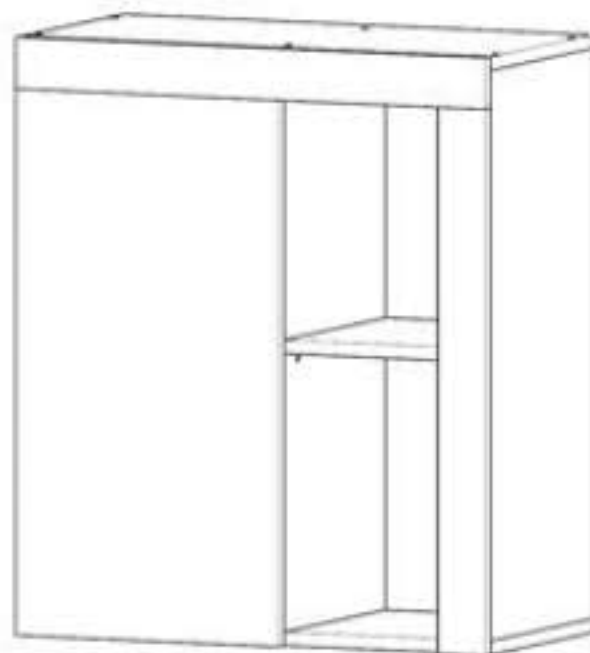

Denumire	Dimensiune	Bucati	Simbol
Tavan	600 288	1	T
Fund	600 288	1	F
Laterale	668 288	2	L
Lezena 1	600 60	1	LZ
Lezena 2	640 60	1	LZ
Polite	304 288	1	P
Polite	248 288	1	P
Intermediara	668 288	1	IM
Front	636 336	1	F

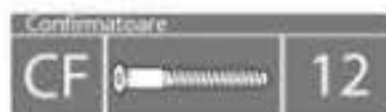

1 Montare

Se fixeaza pe fund cele 3 piese (laterale si intermediara), iar apoi se fixeaza tavanul.

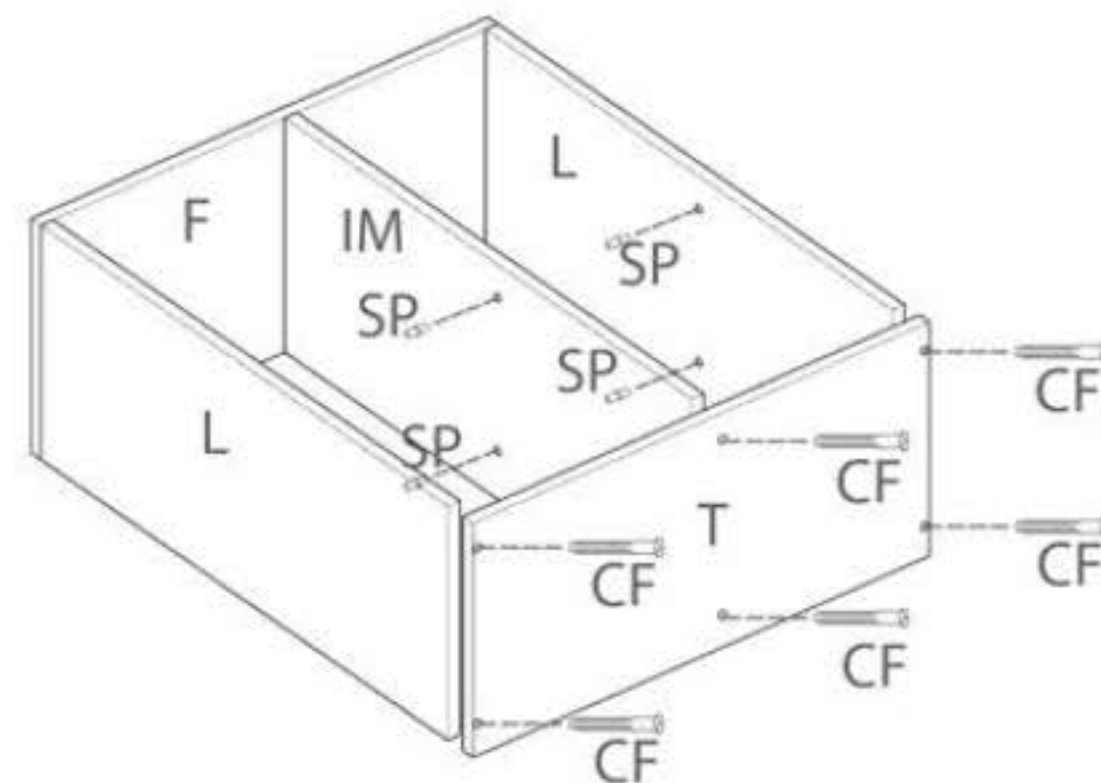
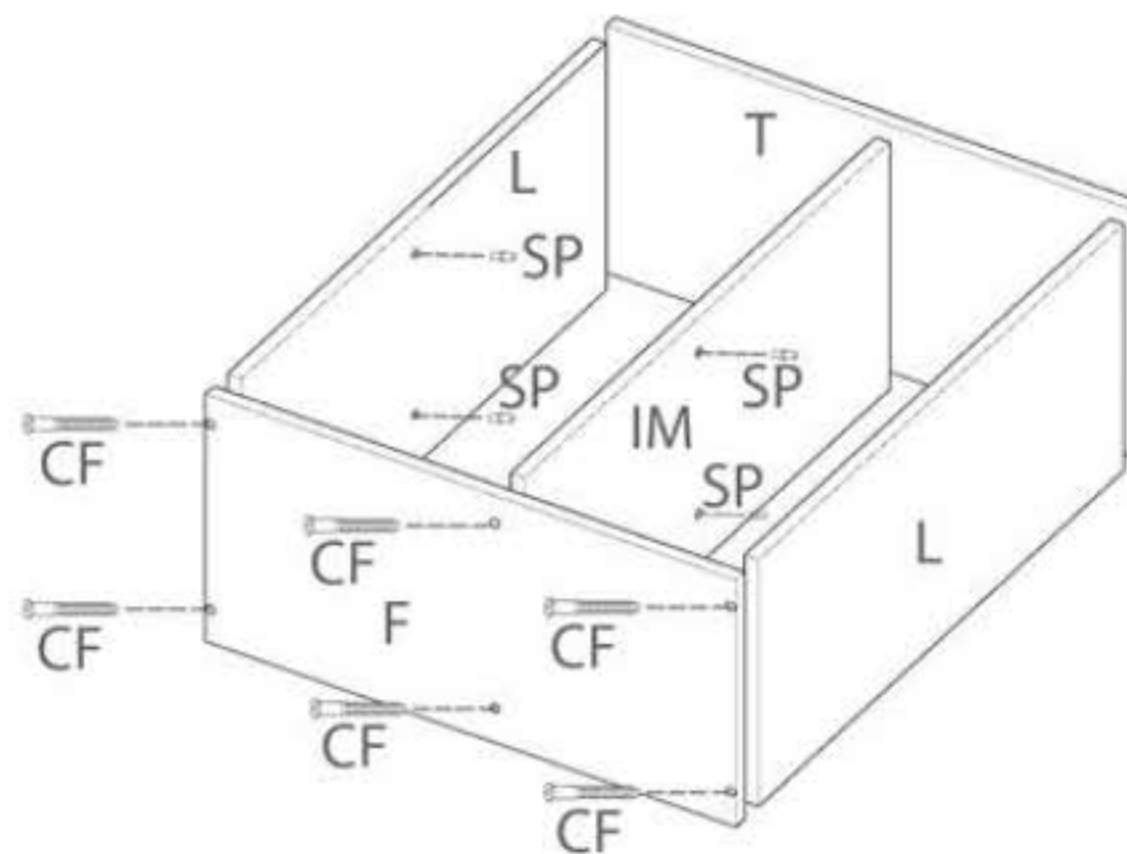

2 Montare HDF

Important! Inainte de a prinde HDF-ul de partea din spate a dulapului, acesta trebuie adus in vinclu, adica la 90 de grade.
Se va intoarce dulapul cu cantul spre podea, va ramane in pozitie orizontala, apoi se va prinde HDF-ul cu cuiute (C).



Dupa prinderea HDF-ului, se aseaza politele mobile pe suporti de polita (SP).

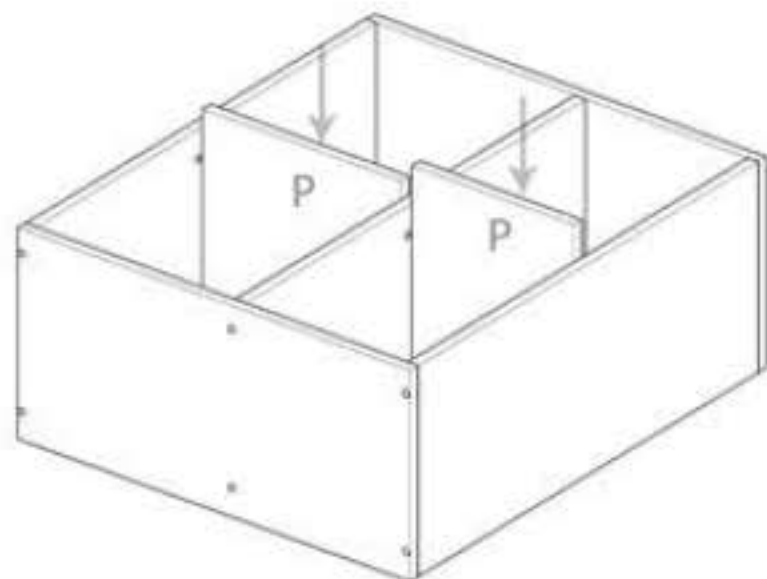

3 Montare lezene si front

Lezenele se monteaza cu ajutorul coltarelor de plastic (CP) care se prind din interiorul dulapului. Coltarele de plastic se vor fixa de laterala si lezana cu surub 3,5x16(S5).

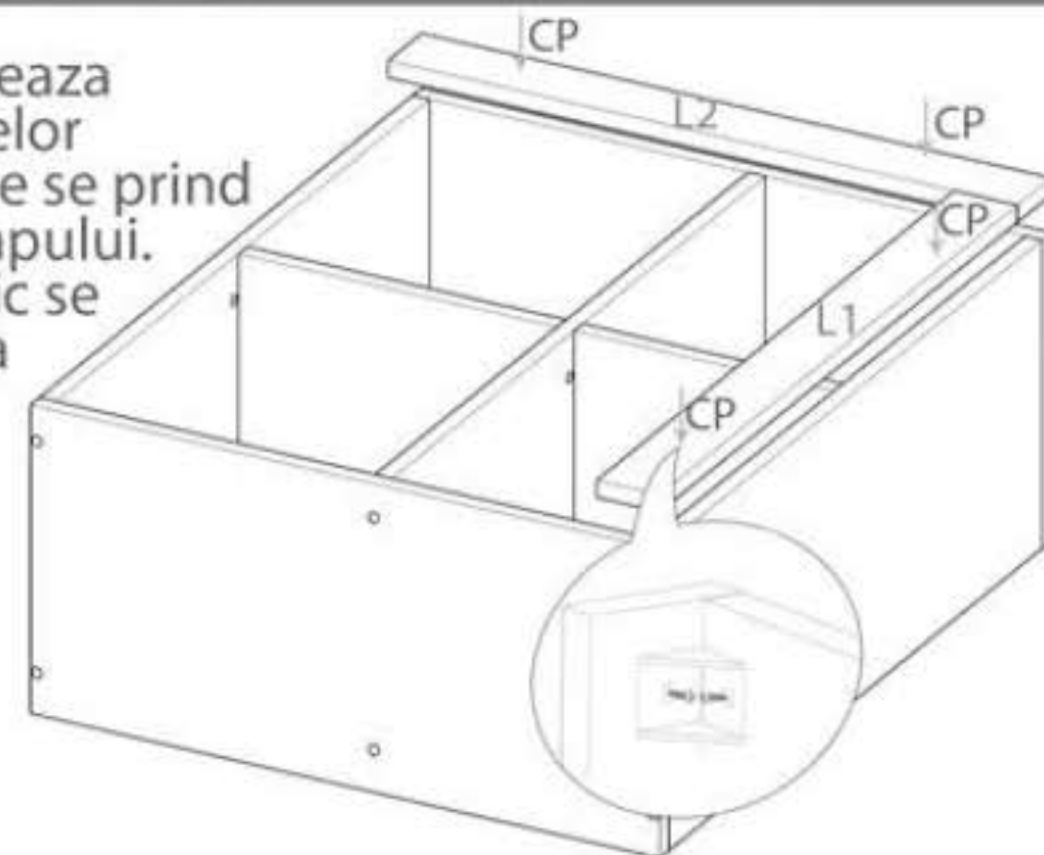

Prinderea balamalelor pe usi se face ca in desenul de mai jos.

Pentru prinderea balamalelor (BA) se vor folosi suruburile 3.5x16 (S5).

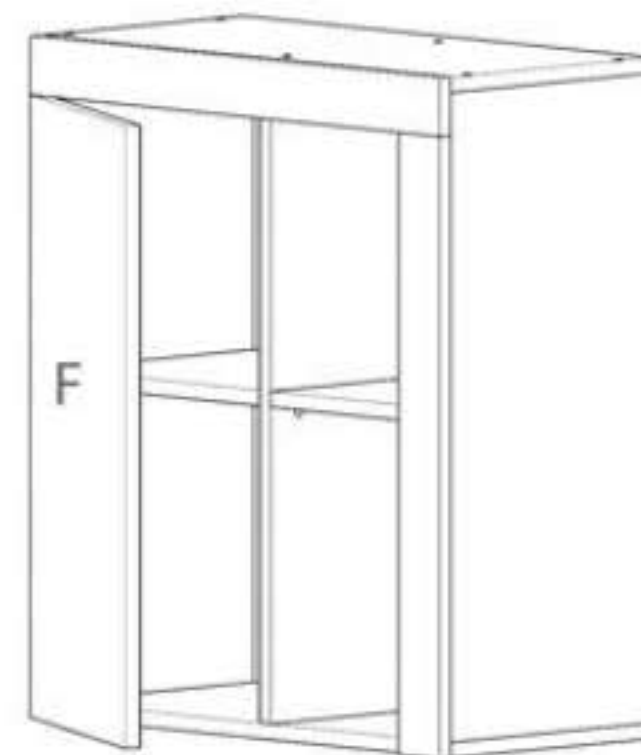
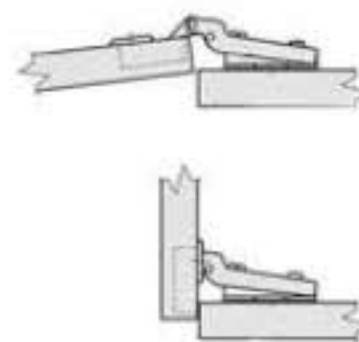

Se regleaza cu ajutorul unei surubelnite PZ2, frontul pentru a fi aliniat.
Manerul(M) se fixeaza pe front cu ajutorul suruburilor S3.